



David Clark COMPANY
INCORPORATED

360 Franklin Street, Box 15054, Worcester, MA 01615-0054
TEL. (508) 751-5800 E-Mail sales@DavidClark.com FAX: (508) 753-5827

C98-30AX
Auxiliary Audio Input Cable
P/N 40892G-09

INSTALLATION SHEET

The C98-30AX Auxiliary Audio Input Cable is used to interface an external audio source into the David Clark Series 9800 Marine Intercom System. Typical sources include portable CD/MP3 players and "Preamp Output" RCA jacks on a car/marine stereo. This sheet provides instructions on the proper installation of the C98-30AX Cable.



IMPORTANT: To connect the C98-30AX to the External Speaker terminals of a communications or weather radio that has balanced audio output, an external transformer MUST be used to prevent possible damage to the radio and/or the Series 9800 Marine Intercom.

Procedure

- Route the C98-30AX Cable between the source and the Master Station. The cable should be routed using under-deck conduits and be as far as possible from radio antenna coax cables and anywhere water may collect. Use wire ties where necessary.
- Connect the cable to the Master Station's jack labeled "Auxiliary Input", see **Figures 1&4**. To connect the cable to the Master Station, align keyways and push. Then firmly turn collar clockwise until it locks into place. Pull back gently on the cable to ensure connector is properly locked.
- **For Portable CD/MP3/Etc. installation:**
 - Plug 3.5mm male into the device's 3.5mm jack labeled "Line Out" or "Headphones"
 - Adjust device's volume to ½ way.

- **For Car/Marine Stereo installation:**

- Locate the “Preamp Output” RCA jacks on the stereo. Some models require an additional adapter from the manufacturer to access these jacks.
- Connect the supplied 3.5mm to RCA adapter cable to the stereo’s output RCA jacks.
- Connect the C98-30AX cable to the adapter cable’s 3.5mm jack.
- Use a waterproof cable seal to ensure that no moisture can enter the contacts of the RCA plugs and the 3.5mm connections.

- **For Weather/2-Way Radio Connection (Listen Only):**



- **It is very important to follow these instructions carefully. Failure to do so may result in serious damage to your radio equipment or the Series 9800 Marine Intercom System.**
- Locate the Speaker/Audio outputs on the radio. Determine the method of connection to the radio (terminals, connector, etc.)
- See **Figure 1** which shows how to connect an isolation transformer between the radio and the C98-30AX cable. Stereo installations require two transformers.
- The installer will fabricate the circuit in **Figure 1**, mount it in an appropriate enclosure, and interface it with the radio and the C98-30AX cable.
- The David Clark Company recommends using a SP-70 transformer (P/N: 09363P-34).
- Note that two 1000pF, 50WVDC capacitors are also required.

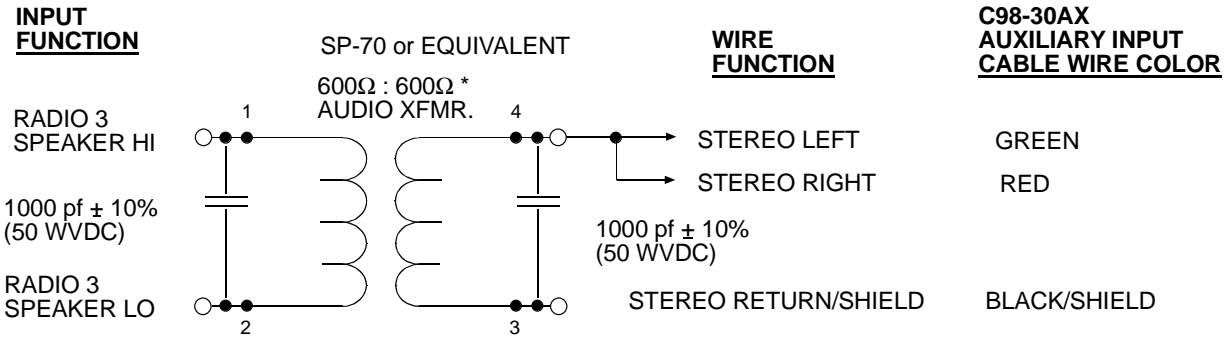

Figure 1: Audio isolation transformer circuit used to interface to Ext. Speaker of 2-Way/Wx radio

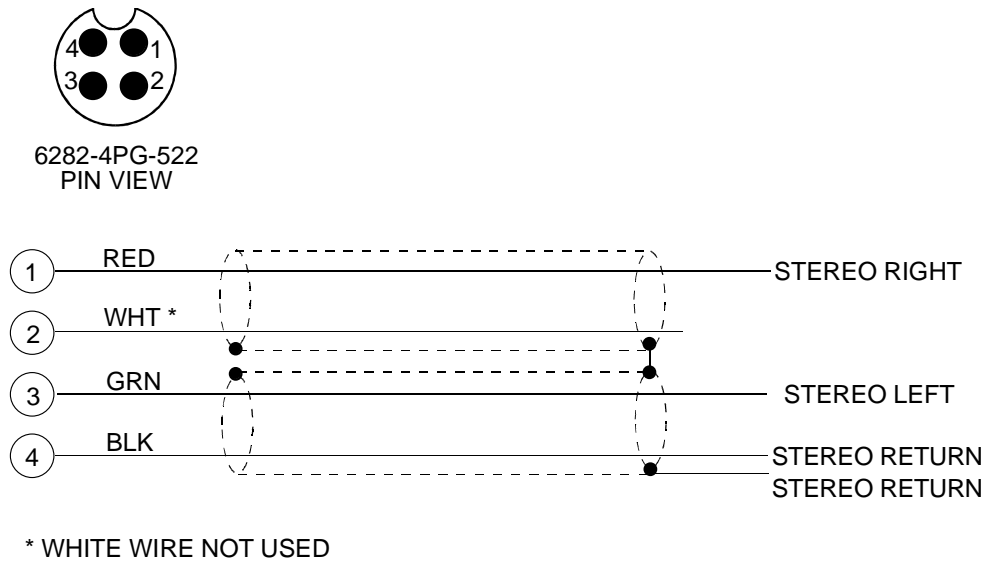

Figure 2: C98-30AX Cable Schematic

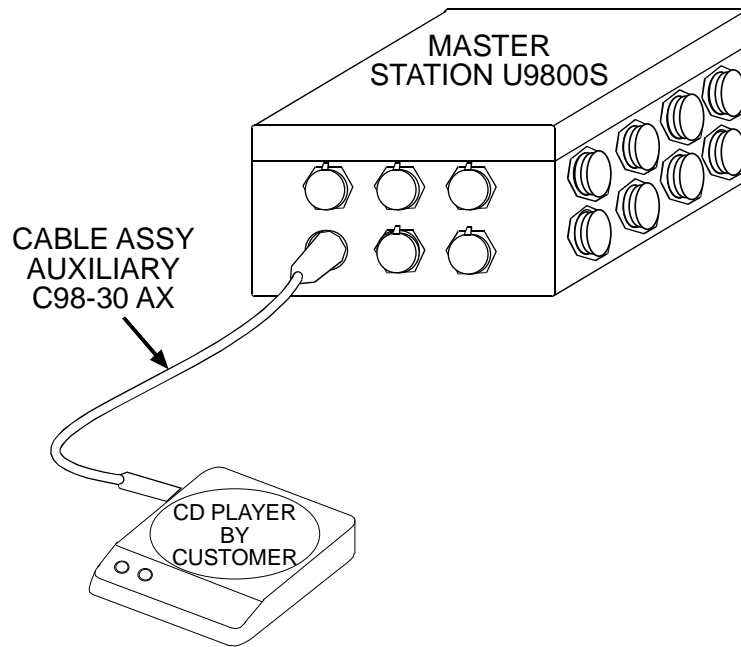

Figure 3: Master Station Auxiliary Cable Connection

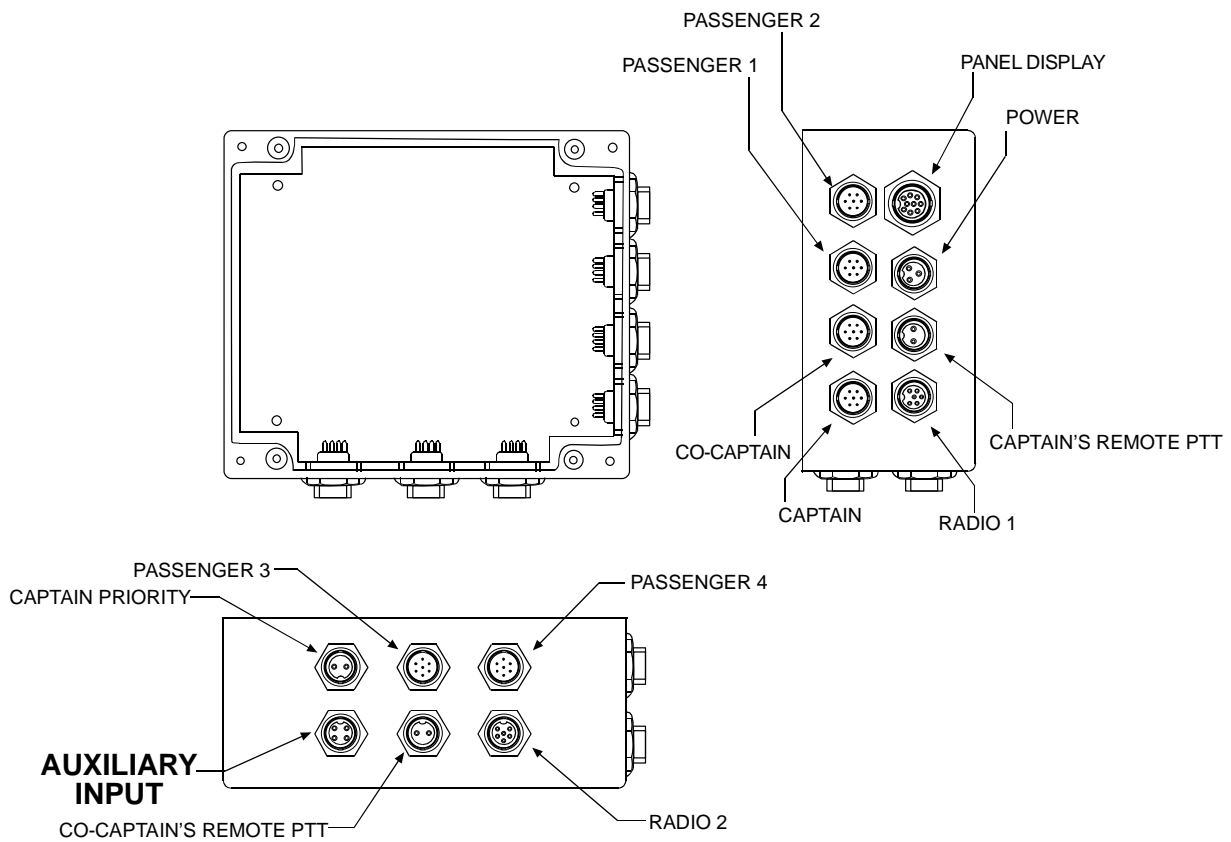

Figure 4: Master Station Connections