

**PARTS LIST
MODEL C35-30**

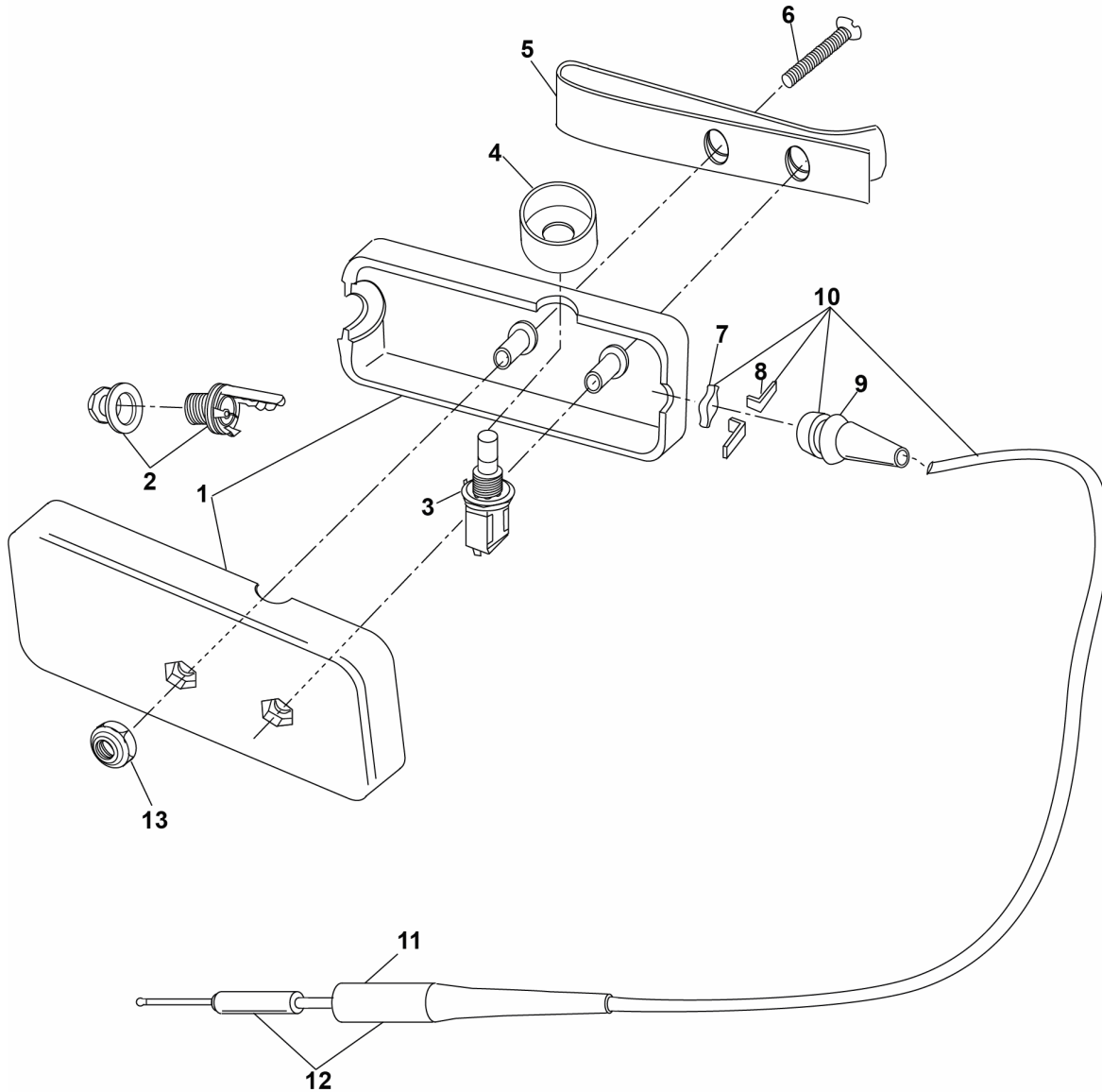

No.	Description	Part No.
1	Case	10815G-09
2	Headset Jack	09228P-03
3	Switch	26619P-13
4	Guard, Push Button	26553P-01
5	Belt Hook	15368P-01
6	Screw (10/pk)	18900G-02
7	Circle Clamp (10/pk)	24433P-14

No.	Description	Part No.
8	Anti-Rotation Clip 10/pk	14176P-02
9	Grommet	14889P-01
10	Comm Cord Kit	18259G-24
11	Bend Relief Sleeve (10/pk)	23100G-06
12	Connector Kit	41090G-32
13	Nut (10/pk)	18900G-03

ELECTRICAL SCHEMATIC
MODEL C35-30

